

# Towing Accessories

TOWING  
ACCESSORIES

Class III & IV Bolt-on Receivers .....	G-3 - G-4	Combination Pintle Hitches .....	G-17
Bumper Receiver Hitches & Receiver Tubes.....	G-4	Pintle Hooks.....	G-18
Drop Hitches .....	G-4	Duplex Hitch.....	G-18
B&W Heavy Duty Receiver Hitches & Ball Mounts...	G-5	Gooseneck Channels.....	G-19
Receiver Ball Mounts & Pintle Mounts .....	G-6	Gooseneck Hitch Plates .....	G-19
Ready Tow Loaded Ball Mounts.....	G-6	Folding Gooseneck Hitch Balls.....	G-19
Cushioned Ball Mounts .....	G-7	Folding Ball Mounting Kits .....	G-20
Specialty Ball Mounts .....	G-7	5th Wheels.....	G-20
Locking & Non-Locking Ball Mounts.....	G-7	King Pins .....	G-20
Inventive Towing Products .....	G-8	Pro Series 5th Wheel Hitches.....	G-21-24
5th Wheel to Gooseneck Adapter .....	G-9	Hijacker RV 5th Wheels & Gooseneck Hitches .....	G-25
Adjustable Locking Ball Mounts .....	G-9	Hijacker Installation Brackets & Mounting Rails.....	G-26
Hitch Balls.....	G-10-G-11		
Hitch Ball Wrench.....	G-12		
Swift Hitch™ Wireless Hitching Camera System .....	G-12		
B&W Multi-Ball Adjustable Receiver Hitches .....	G-13		
B&W Pintle Hitches.....	G-14		
B&W Turnover Ball Gooseneck Hitches.....	G-14		
B&W RV 5th Wheel Hitches & Accessories .....	G-15		
Weight Distribution Hitches .....	G-16		
Cargo Platforms .....	G-16		
Receiver Accessories .....	G-16		
Smooth Shank Hitch Balls.....	G-17		

## Informational Pages

Receiver Hitch Types.....	G-2
Selecting a Ball Mount with Correct Rise or Drop.....	G-13

## Receiver Hitch Types

### Custom Fit 1 Piece

Custom fit hitches are the easiest to install. These application specific hitches are available in Class II, Class III, Class IV, and Heavy Duty.

### Multi-Fit 3 Piece

Designed to fit a wider range of vehicles than Custom Fit hitches, the Multi-Fit units require some assembly. Popular for retail and when stocking a limited line of hitches, the Multi-Fit units are available in Class II, Class III, and Class IV.



### Choose the right hitch to handle the load

Trailer Types:						
Hitch Class:	Class I	Class II	Class III	Class IV	5th Wheel	Gooseneck
Maximum Load Capacity:	Gross Trlr Weight Up to 2,000 lbs. Tongue Weight Up to 200 lbs.	Gross Trlr Weight Up to 3,500 lbs. Tongue Weight Up to 350 lbs.	Gross Trlr Weight Up to 5,000 lbs. Tongue Weight Up to 500 lbs.	Gross Trlr Weight Up to 12,000 lbs. Tongue Weight Up to 1,200 lbs.	Gross Trlr Weight Up to 24,000 lbs.	Gross Trlr Weight Up to 25,000 lbs. Tongue Weight Up to 6,250 lbs.
Tow Vehicle						
Sub Compact & Compact Cars	X	Not Recommended	Not Recommended	Not Recommended	Not Applicable	Not Applicable
Mid Size Cars	X	X	Not Recommended	Not Recommended	Not Applicable	Not Applicable
Mid Size Pickups & Sport Utility Vehicles & Minivans	X	X	X	Not Recommended	X Pickups Only	X Pickups Only
Full Size Cars Pickups & Sport Utility Vehicles & Vans	X	X	X	X	X Pickups Only	X Pickups Only

Gross Trailer Weight is the total weight of the trailer as it is towed. This includes the weight of the trailer and all of its contents.

Tongue Weight is the load supported by the hitch when the trailer is connected to the trailer ball. Excess tongue weight will cause unstable towing as weight is shifted from the vehicle's front suspension to the rear suspension.

MODEL	NOTES	YEAR	PART#	REF#	Wt. Carrying	Wt. Distributing
<b>CHEVROLET &amp; GMC Full Size Pickups</b>						
SILVERADO/SIERRA/	3/4 & 1 TON/NEW STYLE/8' BED					
	2500HD/3500 SERIES.....	2001-07	RRH14008	314932	10000	12000
CHEVY CLASSIC & GMC	6' & 8' BED/OLD STYLE.....	1988-00	RRH14081	314938	10000	12000
GM	1500 NEW BODY.....	2007-11	RRH13301	314941	6000	10000
CHEV/GMC	1500 / 2500 LD.....	1999-11	RRH13322	314942	6000	10000
GM	1500 NEW BODY.....	2007-11	RRH14301	314943	10000	12000
GM	2500 HD & 3500, 6' & 8' BED.....	2001-10	RRH13208	314944	8000	12000
CHEVY/GM	2500 HD/3500 LONG BED.....	2011	RRH13061	314945	8000	12000
SILVERADO/SIERRA/Z71	REG. & EXTENDED 6' & 8' BED, 1500/2500 LD EXCEPT SS.....	1999-07	RRH13332	314946	6000	10000
SILVERADO/SIERRA/Z71	REG. & EXTENDED 6' & 8' BED, 1500/2500 LD EXCEPT SS.....	1999-07	RRH14332	314947	10000	12000
GM	2500 HD/3500 6' & 8' BED.....	2001-10	RRH15208	314948	12000	14000
CHEVY/GMC	2500 HD/3500 SHT BED.....	2011	RRH13062	314950	8000	12000
SILVERADO/SIERRA/	3/4 & 1 TON/NEW STYLE/8' BED					
	2500 HD/3500 SERIES.....	2001-07	RRH13008	314973	6000	10000
CHEVY & GMC	3/4 & 1 TON CLASSIC.....	1988-00	RRH13042	314979	6000	10000

<b>CHEVROLET &amp; GMC Mid-Size Pickups, SUV's, &amp; Vans</b>						
ASTRO/SAFARI	ALL EXCEPT 16" SPARE.....	1985-05	RRH13035	314902	4000	6000
TAHOE/DENALI/ESCALADE						
EQUINOX, TORRENT	ALL.....	2004-11	RRH13591	314935	3500	4000
SUBURBAN/YUKON XL/	NEW BODY STYLE.....	2003-06	RRH13422	314936	6000	10000
CHEVY	FULL SIZE VAN.....	1978-96	RRH13016	314939	6000	10000
TAHOE/DENALI/ESCALADE						
CHEVY/GMC 1500/2500	COLORADO/CANYON.....	2004-10	RRH13252	314940	4000	6000
SAVANNAH/EXPRESS	FULL SIZE VAN.....	1996-10	RRH13040	314992	6000	10000
S-10/S-15 PICKUP	ALL INCL. SPORTSIDE.....	1983-04	RRH13021	314993	4000	6000
BLAZER/JIMMY S10/S15	2 & 4 DOOR.....	1995-04	RRH13020	314996	5000	6000

<b>DODGE Full Size Pickups</b>						
DODGE RAM	1/2, 3/4 & 1 TON.....	2002-08	RRH13361	315097	6000	10000
DODGE RAM	ALL.....	2003-10	RRH13333	315099	6000	10000
DODGE RAM	1/2, 3/4 & 1 TON.....	2003-10	RRH15061	315100	12000	14000
FULL SIZE DODGE, 6' & 8' BED	EXCEPT 2002 RAM 1500.....	1967-02	RRH13310	315137	6000	10000

<b>DODGE / CHRYSLER / PLYMOUTH Mid-Size Pickups, SUV's, &amp; Vans</b>						
DODGE & CHRYSLER MINIVANS	EXCEPT STOW & GO.....	1996-07	RRH12094	315091	3500	N/A
DAKOTA PICKUP	.....	2005-10	RRH13229	315104	5000	5500
DAKOTA PICKUP	2 & 4WD/2 & 4 DOOR.....	1987-04	RRH13280	315105	5000	8000
DURANGO	.....	1998-03	RRH13097	315132	5000	8000

<b>FORD Full Size Pickups</b>						
F150/250 LIGHT DUTY (NEW BODY STYLE)	INCLUDES SUPER CREW.....	1997-03	RRH14355	315007	10000	12000
F250/F350	SUPERDUTY.....	1999-09	RRH15004	315009	12000	14000
F250/F350	SUPERDUTY.....	1999-11	RRH15000	315010	12000	14000
F150	SQUARE TUBE.....	2006-08	RRH13360	315073	6000	10000
F150	ROUND TUBE.....	2006-08	RRH13365	315075	6000	10000
F-150	.....	2004-05	RRH13352	315081	6000	10000
F150	SQUARE TUBE.....	2009-10	RRH13368	315074	6000	11000
F150/250 LIGHT DUTY	INCLUDES SUPER CREW.....	1997-03	RRH13355	315083	6000	10000

<b>FORD / LINCOLN / MERCURY Mid-Size Pickups, SUV's, &amp; Vans</b>						
FULL SIZE VANS	EXCEPT STEP BUMPER.....	1975-06	RRH13053	315015	5000	7500
VAN	E-150/250/350.....	2000-10	RRH13055	315016	6000	8000
FORD RANGER PICKUP	.....	1983-10	RRH13019	315041	4000	6000
FORD ESCAPE, MERC MARINER	.....	2005-11	RRH13650	315046	3500	5000
EXPLORER & MOUNTAINEER	INCLUDES OVERSIZED SPARE.....	1991-03	RRH13540	315067	4000	6000

MODEL	NOTES	YEAR	PART#	REF#	Wt. Carrying	Wt. Distributing
<b>JEEP</b>						
CHEROKEE		1984-01	RRH13084	315118	5000	6000
GRAND CHEROKEE	INCLUDING W/ SKID SHIELD	1999-04	RRH13051	315122	5000	6000
JEEP GRAND CHEROKEE	W/SPARE	2005-10	RRH13251	315124	5000	5500
JEEP LIBERTY	1 PIECE, ROUND TUBE	2001-07	RRH13244	315129	4000	N/A
WRANGLER (INCL RUBICON)	INCLUDING TUBE BUMPER	1997-06	RRH13408	315138	4000	N/A
JEEP WRANGLER UNLIMITED	2 DOOR	2004-06	RRH13428	315139	4000	N/A
<b>IMPORT TRUCK, VAN, &amp; SUV</b>						
TOYOTA SIENNA VAN		2004-11	RRH13256	316060	3500	5000
TOYOTA RAV4	NO DRILL	2006-10	RRH13509	316063	3500	4000
TOYOTA TACOMA, XRUNNER		2005-11	RRH13323	316080	5000	5500
TOYOTA TACOMA PICKUP	ALL	1995-04	RRH13013	316082	5000	6000
TOYOTA TUNDRA		2000-06	RRH13180	316092	6000	10000
TOYOTA TUNDRA		2007-10	RRH13198	316093	6000	8000
NISSAN XTERRA		2005-10	RRH13514	316101	4000	6000
NISSAN TITAN PICKUP		2004-10	RRH13199	316107	6000	10000
NISSAN FRONTIER TRUCK		2005-10	RRH13241	316112	5000	8000
HONDA ODYSSEY VAN		1999-11	RRH13561	316125	3500	5000
<b>MULTI-FIT RECEIVER HITCHES</b>						
CHEVY & FORD PICKUPS	VARIOUS MODELS	1962-06	RRH13028	315146	6000	10000
DODGE & FORD PICKUPS	VARIOUS MODELS	1967-02	RRH14001	315149	10000	12000
FORD/GM	CREW/CHASSIS CAB	1973-06	RRH14082	315155	10000	12000
GM, DODGE, FORD, TOYOTA	MULTI-FIT	1962-09	RRH13950	315212	5000	N/A

## Bumper Receiver Hitches and Receiver Tubes

TOWING ACCESSORIES



RB12

Choose from our standard Step Bumper Hitch Box or the Bumper Receiver Hitch for an alternative light duty 2" receiver. For custom building your own receiver hitch, 5 lengths of receiver tubes are available.



E-3S

PART NO.	REF NO.	DESCRIPTION
E-3S	318160	STEP BUMPER HITCH W/2" RECEIVER TUBE, BLK, 5K
RB06	318605	RECEIVER TUBE, 6" FOR 2" SQUARE HITCH, PAINTED
RB06UP	318610	RECEIVER TUBE, 6" LONG, FOR 2", UNPAINTED
RB08UP	318615	RECEIVER TUBE, 8" LONG FOR 2", UNPAINTED
RB12	318620	12" RECEIVER TUBE FOR 2" SQUARE HITCH BARS
RB12UP	318624	RECEIVER TUBE, 12" LONG FOR 2", UNPAINTED
RB24	318625	24" RECEIVER TUBE FOR 2" SQUARE HITCH BARS
RB24UP	318630	RECEIVER TUBE, 24" LONG FOR 2", UNPAINTED
RB36UP	318640	RECEIVER TUBE, 36" LONG FOR 2", UNPAINTED
RB36	318650	36" RECEIVER TUBE FOR 2" SQUARE HITCH BARS

## Drop Hitches

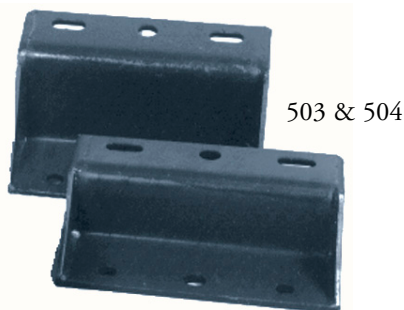

503 & 504

Bolt to rear of a pickup step bumper. These Drop Hitches give a lower hitch point to the trailer, allowing a level ride for towing.

PART NO.	REF NO.	DESCRIPTION
503	318200	4" DROP REAR HITCH
503K	314250	4" DROP REAR HITCH, W/HBK34 MNTG BOLT KIT
504	318400	6" DROP REAR HITCH
504K	318450	6" DROP REAR HITCH, W/HBK34 MNTG BOLT KIT
HBK34	318475	MOUNTING BOLT KIT FOR DROP HITCH

## B&W Heavy Duty Receiver Hitches & Ball Mounts



- Class V rated for 15,000 lbs. weight carrying, 16,000 lbs. weight distributing for Heavy Duty Towing
- Versatility; all 2" ball mounts and other towing accessories will fit B&W Heavy Duty Receivers
- No drill design for easy installation; 3-piece bolt together construction
- B&W brand gives assurance of product quality
- Product is boxed to protect against scratches and ensures that hardware arrives with the hitch
- A choice of pintle mounts and heavy duty ball mounts complements the B&W Heavy Duty Receiver and will work with other brands too



BMHD30010



BMHD30012



BMHD30014



PMHD14002

TOWING  
ACCESSORIES

PART NO.	REF NO.	DESCRIPTION
BWRH25189	314955	B&W HD REC HITCH, 15K 01-07 CHEV/GMC 3/4&1 TON
BWRH25198	315012	B&W HD REC HITCH, 62-09 TRUCKS (SEE NOTES), 16K
BWRH25230	315013	B&W HD REC HTCH, 15K 99-09 F250/F350&07-09 F450
BWRH25211	315102	B&W HD REC HITCH, 15K 03-09 DODGE 3/4&1 TON
BMHD30010	319008	2"HD BL MNT 2"DROP, 6" SHANK, 16K
BMHD30012	319208	2"HD BL MNT 4"DROP, 6" SHANK, 16K
BMHD30014	319408	2"HD BL MNT 6"DROP, 6" SHANK, 16K
PMHD14002	319629	FOR 2" RCVR 8 HOLE, 3 POSITION, 16K, 9" SHANK



**MADE IN THE USA**

## Receiver Ball Mounts and Pintle Mounts

Designed to fit 2" or 2.5" I.D. receiver tubes. Ball mounts raise or lower ball height for proper trailer towing.

BM01-285



45331



BM01-485



PART NO.	REF NO.	DESCRIPTION	BALL SHANK HOLE SIZE	SHANK LENGTH	CAPACITY
BM01-285	319003	2" DROP OR STRAIGHT	1"	8"	7.5K
BMHD2S	319006	HEAVY DUTY, 2" DROP	1 1/4"	7"	9K
D2525	319020	SUPER DUTY, 2 -1/2" TUBE, 3" DROP	1 1/4"	8"	12K
BM01-485	319203	4" DROP OR 2" LIFT	1"	8"	7.5K
BMHD4S	319206	HEAVY DUTY, 4" DROP	1 1/4"	7"	9K
D2526	319220	SUPER DUTY, 2 -1/2" TUBE, 5" DROP	1 1/4"	8"	12K
45331	319390	MAGNUM 2" HVY DUTY 2" DROP 2 5/16"			15K
45332	319392	MAGNUM 2" HVY DUTY 4" DROP 2 5/16"			15K
BM01-595	319403	5 1/4" DROP OR 4" LIFT	1"	9"	7.5K
BMHD6S	319406	HEAVY DUTY, 6" DROP	1 1/4"	7"	9K
D2527	319415	SUPER DUTY, 2 -1/2" TUBE, 8" DROP	1 1/4"	8"	12K
BM01-895	319503	8" DROP OR 6 1/2" LIFT	1"	9 1/2"	5K
PM6990S	319627	RECEIVER PINTLE MOUNT, 2"	N/A	8"	9K



PM6990S

## "Ready Tow" Loaded Ball Mounts



- All in one product includes ball mount, hitch ball, 5/8" hitch pin & clip
- 3 pack carton provides an attractive retail display with 3 units in a corrugated shelf tray
- Hitch balls are factory torqued when installed on ball mounts providing added convenience & safety
- Quality assurance with Curt, a widely recognized & respected name in towing



45034



45036



45042

PART NO.	REF NO.	DESCRIPTION
45034	319418	2" BALL MOUNT, 2" DROP W/1 7/8" BALL, 5/8" PIN/CLIP
D532MP	319420	2" BALL MOUNT, 2" DROP, 3/PK, 1 7/8" BALL, 5/8" PIN/CLIP
45036	319423	2" BALL MOUNT, 2" DROP W/2" BALL, 5/8" PIN/CLIP
D534MP	319425	2" BALL MOUNT, 2" DROP W/2" BALL, 5/8" PIN/CLIP, 3 PK
45056	319428	2" BALL MOUNT, 4" DROP W/2" BALL, 5/8" PIN/CLIP
D554MP	319430	2" BALL MOUNT, 4" DROP W/2" BALL, 5/8" PIN/CLIP, 3/PK
45041	319450	2" BALL MOUNT, 2" DROP 2 5/16" BALL, 5/8" PIN/CLIP
D45041MP	319452	2" BALL MOUNT, 2" DROP 2 5/16" BALL, 5/8" PIN/CLIP, 3/PK
45042	319455	2" BALL MOUNT, 4" DROP 2 5/16" BALL, 5/8" PIN/CLIP
D45042MP	319457	2" BALL MOUNT, 4" DROP 2 5/16" BALL, 5/8" PIN/CLIP, 3/PK

## Cushioned Ball Mounts

Designed to reduce the shock associated with starting and stopping while towing. Also helps reduce shock caused by shifting loads. For use with 2" receiver tubes.

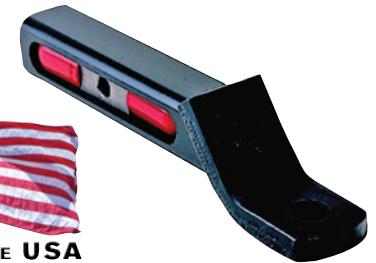

PART NO.	REF NO.	DESCRIPTION	BALL HOLE SIZE	SHANK LENGTH	CAPACITY
AMSC2	319520	2" DROP, 3/4" RISE	1"	8"	10K
AMSC4	319530	4" DROP, 2 3/4" RISE	1"	8"	10K



MADE IN THE USA

## Specialty Ball Mounts

Designed to aid in towing multiple sized couplers with only one ball mount. The triple has a 6,000 lb. capacity for the 1 7/8" ball and 10,000 lb. capacity for the 2" & 2 5/16" balls. The chrome double has a 10,000 lb. capacity for the 2" and 2 5/16" balls.



TBM1620



DBM22516C



PART NO.	REF NO.	DESCRIPTION	RECEIVER TUBE SIZE	SHANK LENGTH
TBM1620	309075	TRIPLE BALL MOUNT, BLACK	2"	8"
TBM1620C	309078	WALLACE CHROME TRI-BALL	2"	8"
DBM22516C	309080	DOUBLE BALL MOUNT, CHROME	2"	8"

TOWING  
ACCESSORIES

## Locking & Non-Locking Aluminum Ball Mounts

DT Aluminum Ball Mounts are precision machined and polished from only the highest quality aluminum available. O-Ring sealed, overlapping stainless steel slide pins have been shear tested to 20,000 lbs. These pins offer reliable corrosion resistance and super high strength operation. Rated at 14,000 lbs. trailer and 2,000 lbs. tongue capacity.

Locking Ball Mounts provide maximum security, with a pick resistant lock cylinder and dust cover; no need for a separate receiver lock or pin & clip.



LOCKING

NON-LOCKING

PART NO.	REF. NO.	DESCRIPTION
LBM8200	319630	LOCKING, 2" DROP, 1" BALL HOLE, 14K
LBM8400	319632	LOCKING, 4" DROP, 1" BALL HOLE, 14K
LBM8600	319634	LOCKING, 6" DROP, 1" BALL HOLE, 14K
DTBM4200	319662	2" DROP, 1" HOLE, 14K
DTBM4400	319664	4" DROP, 1" HOLE, 14K



MADE IN THE USA

# Create Your Own CUSTOM HITCH

The XD Hitch is available in 3 adjustment ranges: 3" drop/2" rise, 6" drop/5" rise and 10" drop/9" rise. With a V-5 rating and 10K tow capacity, this hitch has it all. The XD Hitch has multiple interchangeable attachments, which can transform this product into more than just a hitch. Choose from the Pintle, Step or Swivel-Loc® Hitch Alignment System.

**XD9108**  
The Swivel-Loc Hitch Alignment System has more than 180° swivel angle and covers an arc up to 10" away from the original hitch ball location.



XD9127



**XD9118**  
The XD9118, 6" Platform is perfect for 2" to 4" lifted or lowered vehicles, with a 6" drop, 5" rise, and Tuff Coat Black finish.



**XD9122**  
The XD9122 10" Platform is perfect for 4" to 6" lifted or lowered vehicles, with a 10" drop & 9" rise, and Tuff Coat Black finish.



XD9123



XD9124



**XD9125**  
The XD Workman hitch includes the 6" adjustable black base platform, black double ball attachment (2" & 2 5/16" balls), with pin and clip.

Rated V-5, S.A.E.J.684



XD9121



**MADE IN THE USA**

TOWING ACCESSORIES

PART NO.	REF. NO.	DESCRIPTION
XD9127	306720	XD PINTLE, FOR USE W/3" OR 6" PLATFORMS, BLACK, 10K
XD9125	319640	XD WORKMAN HITCH, INCLUDES 6" ADJ BLK BASE PLATFORM, 2" & 2 5/16" BALLS, BLACK, W/PIN & CLIP
XD9118	319642	XD 6" ADJUSTABLE PLATFORM, BLACK FOR 2" RECEIVER, 10K
XD9122	319643	XD 10" ADJUSTABLE PLATFORM, BLACK FOR 2" RECEIVER, 10K
XD9124	319645	XD BALL MNT BLACK, 7.5K ON 2" BALL, 10K ON 2 5/16" BALL
XD9121	319647	XD STANDARD SIDE PIN, ZINC W/LINCH PIN
XD9123	319649	XD STEP, ALUMINUM, 250 LB MAX, USE W/ANY XD PLATFORM
XD9108	319651	XD SWIVEL LOC HITCH, 2" DROP, BLACK FOR 2" RECEIVER, 6K

## 5th Wheel to Gooseneck Adapters

Converts your 5th Wheel Trailer to a Gooseneck Trailer; allows Gooseneck Hitch owners to pull 5th Wheel Trailers.

- Additional towing flexibility - cushioned 360°
- C5G1216 is adjustable from 12" to 16", C5GX1214 is adjustable from 12" to 14"
- Patented polyurethane insert cushion system reduces road vibrations & bumps
- Safety chains included with each unit
- Tested & Certified 20K GVW and 4K Tongue Weight
- Coupler secures with a standard padlock



*Designed for Short Bed Trucks to increase turning clearance.*



**MADE IN THE USA**

*All units have patented Positive Lock Coupler*

PART NO.	REF. NO.	DESCRIPTION
C5G1216	314620	12"-16" ADJUSTABLE, CUSHIONED 20K
C5GX1214	314622	OFFSET 12"-14" ADJ, CUSHIONED 20K

TOWING  
ACCESSORIES

## Adjustable Locking Ball Mounts

- Fast adjustments & superior theft protection with integrated dual self-locking system
- Double sealed lock cylinder design provides 100% water & corrosion resistance. Never needs to be internally lubricated or maintained.
- Anti-rattle system reduces noise & hitch wear
- Rated 10K towing & 1.5K tongue capacity



PART NO.	REF. NO.	DESCRIPTION
DT-ALBM6600	319652	ADJUSTABLE LOCKING 6" DROP, 2" & 2 5/16" BALLS
DT-ALBM7000	319654	ADJUSTABLE LOCKING 10" DROP, 2" & 2 5/16" BALLS

## Interchangeable Hitch Balls



Simplify hitch ball size changes with Interchangeable Hitch Balls; no tools required. The shaft attaches to the tow vehicle and the balls can be removed from the shaft with the simple push of a pin.



TOWING  
ACCESSORIES

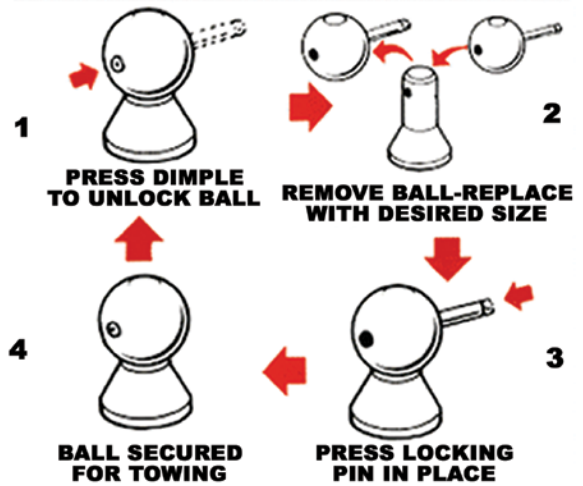

CB004B  
Box Only

PART NO.	REF NO.	DESCRIPTION
CB800B	309086	1-7/8" & 2" x 3/4" SHANK, 3.5K, CHROME
CB900B	309088	1-7/8", 2" & 2-5/16" X 1" SHANK, 10K, CHROME
CB901B	309090	1-7/8" & 2" x 1" SHANK, 10K, CHROME
CB004B	309092	PLASTIC STORAGE BOX W/COVER, FOR 3-CONVERT-A-BALLS

## Hitch Balls

1 7/8" BALL SIZE						
PART NO.	REF NO.	SHANK DIA.	SHANK LENGTH	FINISH	RISE	CAPACITY
17834CLS	309500	3/4"	3"	CHROME	N/A	2K
1781CLS	309900	1"	2 1/8"	CHROME	N/A	2K



2" BALL SIZE						
PART NO.	REF NO.	SHANK DIA.	SHANK LENGTH	FINISH	RISE	CAPACITY
234CLS	310590	3/4"	2 5/16"	CHROME	N/A	3.5K
21CLS	311190	1"	2 1/8"	CHROME	N/A	5K
80200	311400	1"	2"	FORGED	N/A	5K
211RM	311500	1"	2"	ZINC	1"	5K
212RM	311600	1"	2"	ZINC	2"	3.5K
21HT	311700	1"	2 1/8"	HEAT TREATED	N/A	7K
2114CLS	311725	1 1/4"	2 5/8"	CHROME	N/A	10K
2-114-13C	311755	1 1/4"	2 3/4"	CHROME	N/A	13K
2-1CLS	311800	1"	2 3/8"	CHROME	N/A	10K



CEQUENT™  
A TRIMAS COMPANY



*Quality Since 1942*

2 5/16" BALL SIZE						
PART NO.	REF NO.	SHANK DIA.	SHANK LENGTH	FINISH	RISE	CAPACITY
2516-1LS	311850	1"	2 1/8"	CHROME	N/A	7.5K
2516-114	312000	1 1/4"	2 5/8"	CHROME	N/A	10K
2516-114LS	312200	1 1/4"	3 1/4"	ZINC	N/A	9K
2516-1CLS	312300	1"	2 3/8"	CHROME	N/A	10K
2516-114-1	312400	1 1/4"	2 1/4"	ZINC	1"	7K
2516-114-1LS	312435	1 1/4"	3 1/4"	ZINC	1"	7K
2516-114-2	312600	1 1/4"	2 1/2"	ZINC	2"	5K
2516-114-13C	312604	1 1/4"	2 3/4"	CHROME	N/A	13K
2516-112-2	312650	1 1/2"	2 3/4"	MACHINE	2"	30K
80211	312800	1 3/8"	2 1/2"	FORGED	N/A	13K
81371	313000	1 3/8"	2 1/2"	FORGED	N/A	40K
2516-114-HT	313025	1 1/4"	2 1/8"	MACHINE	N/A	30K
5F	313200	1 3/8"	3 1/4"	MACHINE	1"	30K
2516-138-1	313220	1 3/8"	3 1/4"	MACHINE	1"	30K
2516-112CT	313400	1 1/2"	3 1/2"	ZINC	N/A	10K
2516-2CT	313425	2"	3 1/2"	MACHINE	N/A	10K

3" BALL SIZE						
PART NO.	REF NO.	SHANK DIA.	SHANK LENGTH	FINISH	RISE	CAPACITY
32M	313605	2"	3 1/4"	MACHINE	N/A	30K



TOWING  
ACCESSORIES

## Redline Packaged Hitch Balls

The most popular forged Hitch Balls, in attractive clam shell packaging for your retail sales! For pegboard or shelf display.



PART NO.	REF NO.	BALL SIZE	SHANK DIA.	SHANK LENGTH	FINISH	CAPACITY
TA02-025	309015	1 7/8"	3/4"	2 1/8"	CHROME	2K
TA02-045	309025	1 7/8"	1"	2 1/8"	CHROME	3.5K
TA03-025	309040	2"	3/4"	2 1/8"	CHROME	3.5K
TA03-045	309050	2"	1"	2 1/8"	CHROME	6K
TA04-020	309065	2 5/16"	1"	2 1/8"	CHROME	7.5K
TA04-040	309070	2 5/16"	1 1/4"	2 5/8"	CHROME	10K

## Hitch Ball Wrench

# Master Lock



The high torque box ends and long wrench body of this hitch ball wrench allow for increased leverage that will securely tighten hitch ball nuts.

Made of hardened steel with a chrome plated finish, this wrench is corrosion resistant, thus ensuring many years of use.

PART NO.	REF NO.	DESCRIPTION
HBW1812	313607	1-1/8" & 1- 1/2" FOR 3/4" & 1" SHANK, CHRM

## Swift Hitch™ Wireless Hitching Camera System

# SWIFT HITCH™



- Portable, wireless camera system shows a realtime display of your hitch ball, no more guessing where the trailer tongue is!
- Attach the camera to your tailgate with the magnetic base on camera unit & remove it afterward.
- Big 2.5" LCD 960 x 240 resolution full color display ensures accurate hitching.
- With the fully automatic night vision camera, you can accurately hitch your trailer in complete darkness.
- Transmission distance between camera and hand-held display is 300 ft. in daylight and 15 ft. in darkness.
- The water-resistant camera and display are charged by vehicle's 12v accessory port, with a 10-hour battery run time.
- 1 year warranty

PART NO.	REF. NO.	DESCRIPTION
SH02	313618	WIRELESS HITCHING CAMERA SYSTEM



## Selecting a Ball Mount with the Correct Rise or Drop

Follow the simple steps illustrated below to determine the ball mount with enough rise or drop to keep the trailer in a level position.

### To Measure Ball Mount Rise:

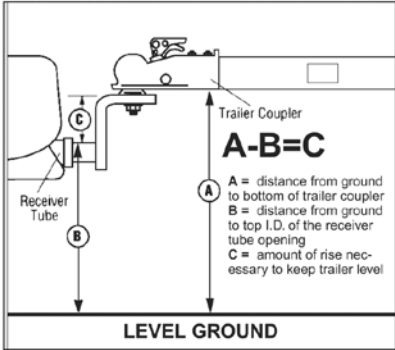

### To Measure Ball Mount Drop:

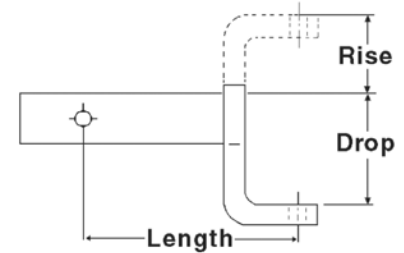
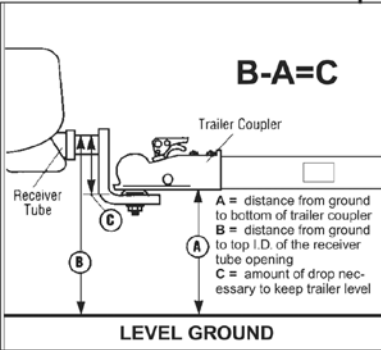

## Multi-Ball Adjustable Receiver Hitch

With a pull of a pin, easily rotate the ball to the desired size. Stows underneath when not in use.

- Class IV Rating
- Adjusts to multiple heights
- Available in several ball configurations



TS10033C  
(Tow Position)



**MADE IN THE USA**

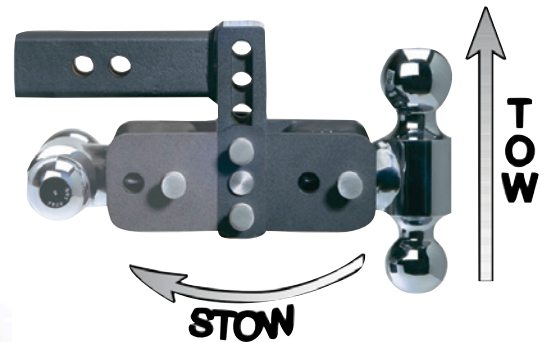
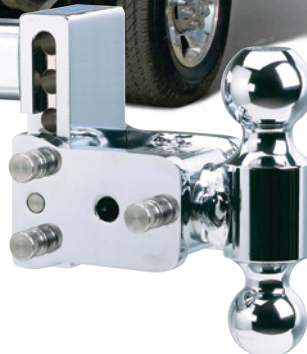

### ONE HITCH... COMPLETE VERSATILITY!

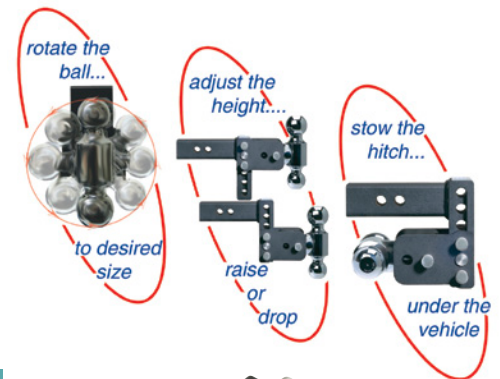

TOWING ACCESSORIES

PART NO.	REF NO.	DESCRIPTION
TS35100B	319670	DRAW BAR FOR B&W TOW & STOW HITCH
TS10025B	319675	TS10033B W/COUNTER DISPL & LITERATURE
TS10033B	319685	DOUBLE BALL MNT 2-5/16" X 2", 3" DROP, 10K
TS10033C	319686	CHROME TOW & STOW 2"X2 5/16" BALL, 3"DRP
TS10040B	319688	DOUBLE BALL MNT 2 5/16" X 2", 7" DROP, 10K
TS10047B	319691	TRI-BALL MNT 2" X 1-7/8" X 2-5/16", 3" DROP, 10K
TS10037B	319694	DOUBLE BALL MNT 2-5/16" X 2", 5" DROP, 10K
TS10037C	319695	CHROME TOW & STOW 2"X2 5/16" BALL, 5"DRP
TS10048B	319697	TRI-BALL MNT 2" X 1-7/8" X 2-5/16", 5" DROP, 10K



TS35100B

## B&W TOW & STOW Pintle Hitch

- Class IV / 1,000 lb MTW / 10,000 lb. GVW
- Adjusts to multiple heights
- 6", 8" and 10" models available
- New stainless steel pins with knurled grip for easier removal & a cleaner look
- Stows underneath when not in use

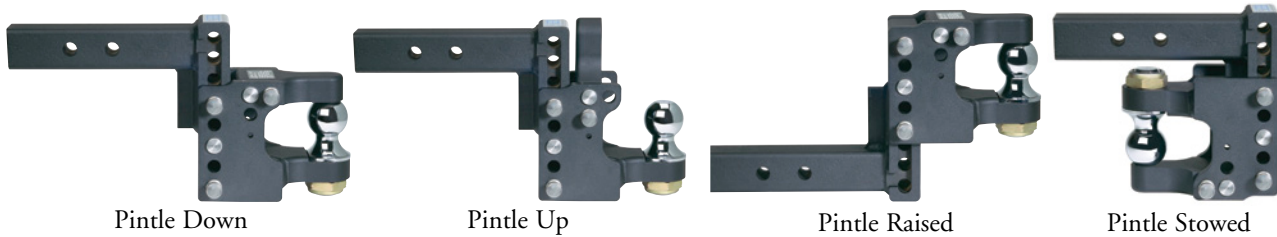

PART NO.	REF. NO.	DESCRIPTION
TS10055B	306700	WITH 2" CHROME BALL, 5" DROP, 16K
TS10056B	306705	2-5/16" CHROME BALL, 5" DROP, 16K

## B&W Turnoverball™ Gooseneck Hitches

The B&W Turnoverball™ System converts from a towing unit to a level bed in less than 30 seconds. Another much appreciated benefit is the ease of installation. The hitch bolts directly to the frame under the bed using the existing holes.

TOWING ACCESSORIES

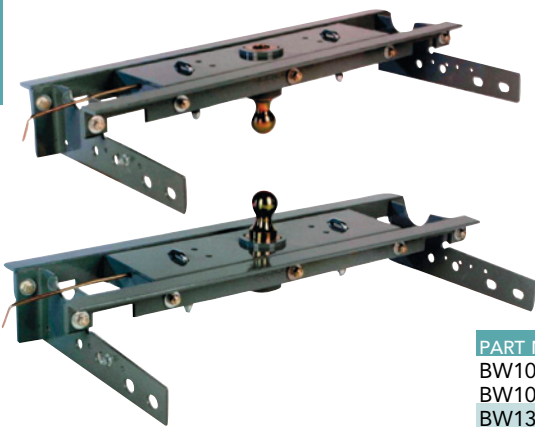

**OFFICIAL HITCH  
OF THE  
PBR & PRCA**



Parts listed below ending in "R" include mounting rails. Capacity rated at 30,000 lbs, tongue weight of 7,500 lbs.

PART NO.	REF. NO.	DESCRIPTION
BW1011R	314629	2011 3/4 & 1 TON CHEVY/GMC PICKUP
BW1007R	314631	07-10 CHEV/GMC 1/2 TON ONLY NEW BXD FRAME
BW1394R	314632	94-01 1/2 T DODGE, 94-02 3/4 TON & 1 TON
BW1059R	314634	99-07 CHEV/GMC 1/2 TON & 3/4 TON LIGHT DUTY
BW1057R	314635	07-10 CHEV/GMC 1/2 TON SB ONLY NEW BXD FRAME
BW1000R	314636	88-98 CHEVY/GMC 1/2, 3/4, 1 TON & 99-00 3/4 & 1 TON
BW1067R	314637	01-10 CHEV/GMC 3/4 TON HD SB OR LB, 07-10 CHEV/GMC 1T NEW BODY W/1 CROSSMEMBER OVR AXLE
BW1050R	314638	88-98 CHEVY/GMC 1/2, 3/4, 1T SB & 99-00 3/4 & 1T SB
BW1062R	314639	01-07 CHEVY/GMC 1T HD (W/2 BED CROSS MEMBERS)
BW1100R	314640	80-98 FORD 3/4, 1T W/O OVERLOAD SPRINGS
BW1110R	314642	80-98 FORD 3/4, 1T W/ OVERLOAD SPRINGS
BW1150R	314644	80-96 FORD 1/2 TON
BW1197R	314646	97-04 FORD OLD BODY STYLE 1/2 TON, LT DUTY 3/4 TON
BW1104R	314648	04-10 FORD F150 1/2 TON NEW BODY STYLE
BW1111R	314651	2011 F-250 & F-350, LONG & SHORT BED
BW1108R	314652	99-10 FORD 3/4 & 1 TON SD & 08-10 F450 W/FCTRY BED
BW1208R	314653	04-11 NISSAN TITAN ALL BEDS
BW1257R	314655	07-11 TOYOTA TUNDRA (NOT CREW-MAX)
BW1309R	314656	09-11 DODGE 1/2 ALL BEDS
BW1316R	314659	02-08 DODGE 1/2 TON EXCPT MEGA
BW1307R	314665	06-11 DODGE MEGA CAB ALL SIZES
BW1310R	314667	03-11 DODGE 3/4 & 1 TON SHT & LONG BED



## B&W RV 5th Wheel Hitches & Accessories

The RV 5th wheel Companion™ is capacity rated at 18,000 lbs, tongue weight of 5,500 lbs.

Our Turnover Ball “flat bed kit” (Part No. BW1500) is specially designed to be built into a custom or home-made flat bed, to be used with 1/8” thick floorplate, which consists of the ball socket, a 2 5/16” ball, and the latch pin assembly.

Also available is a flat bed version of our Companion™ 5th Wheel RV hitch, (Part No. BW3050R) as shown below.

### Companion 5th Wheel RV Hitch for FLATBEDS

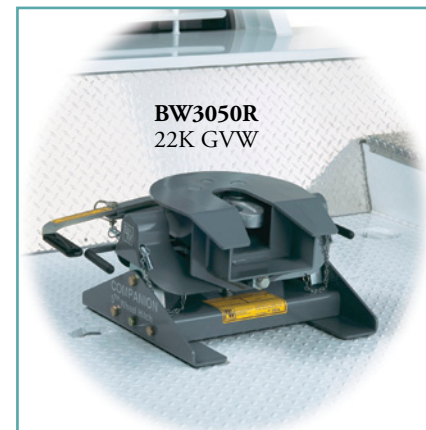

TOWING  
ACCESSORIES

PART NO.	REF. NO.	DESCRIPTION
BW1500	314660	GN HITCH FLAT BED TRUCKS
BW3050R	314662	RV 5TH WHL COMPANION™ FLAT BED
BW3000	314700	RV 5TH WHEEL COMPANION™

### Companion 5th Wheel RV Hitch

- Powder coat finish
- Full 1 1/8” locking jaws
- Cam action latching mechanism
- No mounting rails in the truck bed
- Vibration dampening polyurethane bushings
- Effortless hook-up & release, even under load



Accessories		
PART NO.	REF. NO.	DESCRIPTION
BW1600	314661	GN HITCH REPL SAFETY CHAIN LOOPS
BW2050	314668	2 5/16” HI-RISE HITCH BALL
BW2000	314676	REPLACEMENT 2 5/16” HITCH BALL
BW4000	314701	GN HITCH KING PIN
BW4085	314705	TURNOVER BALL GN EXTENDER 2 5/16” BALL
GNXA8030	314710	HITCH INSTALLATION HELPER



## Weight Distribution Hitches



Ideal for use when towing trailers with heavier tongue weights. A Weight Distribution Hitch applies leverage between the tow vehicle and trailer resulting in a more level ride with less stress on the rear of the tow vehicle. Use with a 2" receiver hitch. Rated at 10,000 lbs. towing capacity.

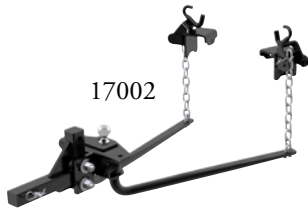

17002



17302



17200

40093



17108

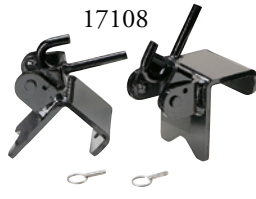

PART NO.	REF NO.	DESCRIPTION
17002	318078	WT DIST HCH, 10K ROUND BAR, ADJ SHANK
17302	318080	WT DIST HCH, 10K TRUNNION, ADJ SHANK
17200	318084	SWAY CNTRL ARM & BALL, USE W/WT DIST HITCH
17108	318090	LIFT BRACKET KIT FOR WT DIST HITCH PAIR
40093	318088	SWAY CNTRL HCH BALL, 1 1/4" FOR WT DIST HITCH

## Cargo Platforms



18131



LTG-60



Extend your cargo space with these hitch mounted platforms. The 20" x 60" platforms are for use with 2" receiver hitches and feature a mesh floor, convenient tie loops and a 500 lb. capacity. The powder coat finish helps prevent corrosion. The 18130 & 18131 have 6" high sides to help keep cargo secure.



18130

PART NO.	REF NO.	DESCRIPTION
18130	318538	CARGO CARRIER BASKET FOR 2" RCVR HCH
18131	318542	CARGO CARRIER BASKET FOLDING FOR 2" RCVR HCH
LTG-60	318550	HITCH MNT CARGO CARRIER, BOXED

## Receiver Accessories

We have hitch pins available in bulk or packaged for easier display. Other accessories are listed below. See K-13 - K-16 for security devices.

TS35010



RHPP2

TS35020



SILENCER PAD



1465DAT

RECEIVER HITCH PINS		
PART NO.	REF NO.	DESCRIPTION
RHPP1	319743	RECVR HITCH PIN, 5/8" X 3", W/KEEPER (BULK)
RHPP2	319747	RECVR HITCH PIN, 1/2" X 3", W/KEEPER (BULK)
1465DAT	319748	5/8" STAINLESS STEEL HITCH PIN, W/PIVOT KEEPER
HP583	319750	RECVR HITCH PIN, 5/8" X 3", W/KEEPER (PKG)
HP12	319755	RECVR HITCH PIN, 1/2" X 3", W/KEEPER (PKG)
TS35010	319758	TOW & STOW HITCH PIN W/ KEEPER, 5/8" X 4-1/2", S/S
18-2058	319810	5/8" LOCKING RECVR HITCH PIN, FOR 2" RECVR

TA06-125



18-2058



D2505



RECEIVER TUBE COLLARS & COVERS		
PART NO.	REF NO.	DESCRIPTION
HBB1	320000	HITCH BALL BUSHING, REDUCES 1" HOLE TO 3/4"
D2505	320120	ADAPTER SLEEVE, 2.5" TO 2" RECEIVER, BLACK
TS35020	320220	SILENCER PAD FOR RECEIVER, BLK
TA06-100	320240	2" RECEIVER TUBE COVER, CHROME
TA06-125	320245	2" RECVR TUBE COVER, BLACK

For Receiver Locks see page K-16

## Smooth Shank Hitch Balls

Ideal for use on Gooseneck Channels with a 2 3/16" smooth shank hole, such as 638CS, 642CS and 644CS.

PART NO.	REF NO.	BALL SIZE	SHANK DIA.	SHANK LENGTH	DESCRIPTION	CAPACITY
2516-2316SM	313600	2 5/16"	2 3/16"	4"	BALL W/O COLLAR	30K
GNC	313615	N/A	2 3/16" I.D.	N/A	COLLAR ONLY	N/A



2516-2316SM

## Combination Pintle Hitches



Combination pintle hitches are ideal for farm, construction and general use. Packaged for showroom display, these pintle hitches include all necessary mounting hardware. Imported.

PART NO.	REF NO.	BALL SIZE	MAX. WT. TONGUE	BALL CAPACITY	PINTLE CAPACITY
CPH-2000	306104	2"	500	5K	12K
CPH-2516	306105	2 5/16"	800	8K	12K



TOWING  
ACCESSORIES

Wallace Forge drop-forged Combination Pintle Hooks/Ball Hitch include a chrome ball. Hitch balls are interchangeable.

DPH and DPR feature a two-stage locking mechanism that locks when used as a pintle hitch or ball hitch.



DPR2000



DPR2516

PART NO.	REF NO.	BALL SIZE	MNTG. HOLES	MAX. WT. TONGUE	BALL CAPACITY	PINTLE CAPACITY
DPH2000	306110	2"	4	3K	10K	16K
DPH2516	306120	2 5/16"	4	3K	10K	16K
2000DPRB	306145	2"	REPL. BALL FOR DPH/DPR SERIES		10K	16K
2516DPRB	306155	2 5/16"	REPL. BALL FOR DPH/DPR SERIES		10K	16K
DPR2000	306160	2"	FOR 2" RECEIVER		1K	10K
DPR2516	306170	2 5/16"	FOR 2" RECEIVER		1K	10K



S15T

Popular in the construction, municipal utility, and transportation industries, the following Pintle Hooks can be used when towing light, medium, or heavy weight trailers. Available in 4, 6, or 10 bolt mounting patterns.



PH30RP41

PART NO.	REF NO.	DESCRIPTION	BRAND	MNTG. HOLES	MAX. WT. TONGUE	GROSS WT. TRAILER
PH10RP41	306397	RIGID TYPE	HOLLAND	4	2K	10K
R5T	306401	RIGID TYPE	WALLACE	4	2K	10K
R15T	306601	RIGID TYPE	WALLACE	4	6K	30K
PH30RP41	306602	RIGID, W/FAST LATCH	HOLLAND	4	6K	30K
PH30SA41	306799	SWIVEL W/ SPRING CUSHION	HOLLAND	6	4K	20K
S15T	306801	SWIVEL W/ SPRING CUSHION	WALLACE	6	4K	30K



**FastLatch™ PINTLE HOOKS FEATURE:**

- Automatic Secondary Lock for Safety
- No Cotter Pins or Chains for Convenience
- NoLube™ Technology for Lubrication-Free Low Maintenance

TOWING ACCESSORIES

**ONE HANDED LATCH OPERATION!**

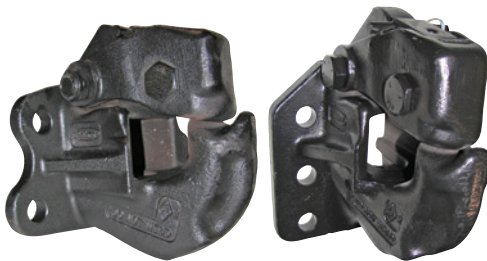

PH210RN11

PH410RN11

HEAVY DUTY						
PART NO.	REF NO.	DESCRIPTION	MNTG. HOLES	MAX. WT. TONGUE	GROSS WT. TRAILER	
PH210RA11	307001	RIGID TYPE W/AIR CUSH	4	18K	90K	
PH210RN11	307201	RIGID TYPE, NO AIR CUSH	4	18K	90K	
PH410RA11	307401	RIGID TYPE W/AIR CUSH	6	20K	100K	
PH410RN11	307599	RIGID TYPE, NO AIR CUSH	6	20K	100K	

**SAF-Holland Duplex Hitch**

This Pintle Hook/2" Ball Hitch is well suited for use in the utility, construction and rental industries. The Pintle Hook and 2" Ball are part of a **single durable steel casting**, which eliminates the possibility of the ball coming loose.



PART NO.	REF NO.	BALL SIZE	MNTG. HOLES	MAX. WT. TONGUE	BALL CAPACITY	PINTLE CAPACITY
BH200RN41	306300	2"	4	3,000	10K	20K

## Gooseneck Channels

A real time saver for Gooseneck hitch installers! When equipping pick-ups for gooseneck trailer towing, use pre-cut channels for under-the-bed installation of hitch balls with either a 1 1/4" or 2 3/16" shank. These 6" wide channels are available in 38", 42" or 44" lengths to fit most 1/2 thru 1-ton pickups.

PART NO.	REF. NO.	DESCRIPTION
638CP	314755	6" X 38" CHANNEL, 1 1/4" BALL HOLE
642CP	314760	6" X 42" CHANNEL, 1 1/4" BALL HOLE
644CP	314761	6" X 44" CHANNEL, 1 1/4" BALL HOLE
638CS	314770	6" X 38" CHANNEL, 2 3/16" SMOOTH SHANK COLLAR
642CS	314775	6" X 42" CHANNEL, 2 3/16" SMOOTH SHANK COLLAR
644CS	314781	6" X 44" CHANNEL, 2 3/16" SMOOTH SHANK COLLAR

642CP

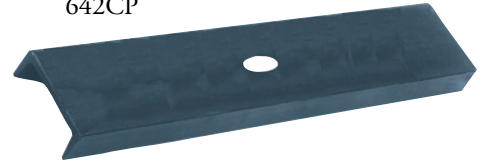

## Gooseneck Hitch Plates

Heavy Duty Gooseneck Plates are economical and offer universal installation. Hitch plates 2516BPD and 2516BP-1RD are equipped with two 5/8" D-rings for safety chain attachment points.



2516BP-1RD



GNP

PART NO.	REF. NO.	BALL SIZE	PLATE SIZE	RISE	CAPACITY
2516BPD	314401	2 5/16"	3/8" X 15" X 40"	N/A	30K
2516BP-1RD	314430	2 5/16"	3/8" X 13" X 42"	1"	30K
GNP	314500	N/A (1 1/4" BALL HOLE)	1/4" X 18 1/4" X 42"	2 1/2"	NR

## Folding Gooseneck Hitch Ball



TOWING  
ACCESSORIES

Atwood offers a machined 2 5/16" hitch ball that folds down flush with the truck bed when not in use, leaving the bed clear for full utilization. Comes with safety chain tie down loops that work in conjunction with our Safety Chains found on page K-17.

PART NO.	REF. NO.	BALL SIZE	PLATE SIZE	CAPACITY
B25CL	314602	2 5/16"	12" X 14"	25K

## Folding Gooseneck Hitch Ball

Wallace Forge offers a drop-forged 2 5/16" hitch ball, a square hitch ball base and door for greater stability, a secondary spring loaded pin for added security when the hitch ball is in use, and safety chain tie downs which provide connections for Safety Chains found on page K-17. (Safety chains pictured, but not included).

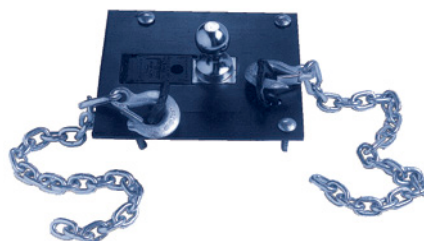

PART NO.	REF. NO.	DESCRIPTION	BALL SIZE	PLATE SIZE	CAPACITY
WF2516-FB	314610	FOLDING GN HITCH BALL	2 5/16"	12" X 14"	30K
WF2516-MK2	314617	BOLT ON MTNG KIT FOR FOLDING BALL ASSEMBLIES			

## Folding Ball Mounting Kits



These kits include mounting rails and hardware needed for installing most brands of folding gooseneck hitch balls. These kits are designed to provide easy installation on most Dodge, Ford and GM pickups.

PART NO.	REF. NO.	DESCRIPTION
MK6984	313643	80-98 FORD F250HD/F350/SD
MK69671	313646	99-09 CHEV/GMC TRUCKS
MK69682	313648	DODGE 1500 02-08, HD 03-10

## 5th Wheels



FW0001

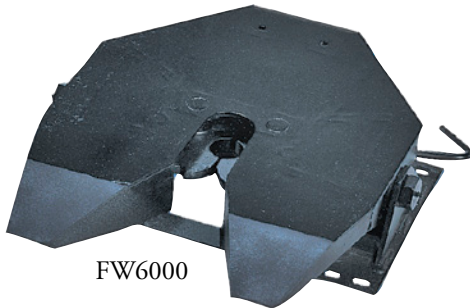

FW6000

Ideal for use on R.V., utility or industrial trailers and accepts standard 2" SAE king pins. All three are rated at 32,000 lbs. capacity.

PART NO.	REF. NO.	DESCRIPTION	PIVOT STYLE	APPLICATION
FW0001	296200	5TH WHL, 12" DIA.	SINGLE	INVERTED ON TRAILER
FW0002-45	296400	5TH WHL, 12" DIA.	DOUBLE	INVERTED ON TRAILER
FW6000	296600	5TH WHL, 22" DIA.	SINGLE	MTD ON TOW VEHICLE

## King Pins

2" SAE King Pins are the standard of the industry and are suitable for use in all over-the-road applications. The Holland Retractable King Pin disappears into the truck bed when not in use and is to be used with inverted 5th wheel trailers equipped with FW0001 or FW0002-45.



T809

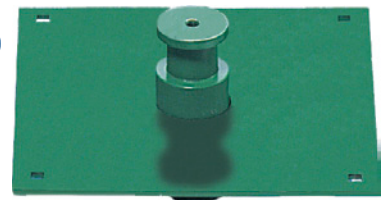

FW0030

PART NO.	REF. NO.	DESCRIPTION	APPLICATION
T809	297200	RIGID WELD-ON, 3/8" BOLSTER	PIN BOX ON TRAILER
FW0030	297400	RETRACTABLE, 4 BOLT, 14" X 14"	BED OF TOW VEHICLE

## Pro Series™ 5th Wheel Hitches

### Pro Series™ 16K

- Covers all 16K user requirements
- Full floating head for improved hooking/unhooking, as well as ride
- Has a proven enhanced slide bar system for worry free towing
- Lightweight, easy to install and remove
- Adjustable height, from 13” to 17”
- One-piece formed legs, provides wider footprint for superior stability
- Sidewinder compatible, preferred for short bed pick-ups
- Fits 10 bolt rail kit (#30035)
- Compatible slider system available
- 3-year limited warranty



Kit Part#: 30130



NOTE: Will not fit trucks with beds shorter than 6’ in length unless used with Sidewinder. Will not fit trucks with flareside/stepside.

PART NO.	REF. NO.	DESCRIPTION
30130	297027	16K 5TH WHL HEAD, SUPPORT, LEGS 10 BOLT RAIL KIT

### Pro Series™ 16K with Square Tube Slider

Designed for shortbed trucks to provide clearance and prevent damage to truck and trailer in tight spaces at slow speeds.

- 10” travel front to back
- Adjustable with trailer attached
- Can be used with full size or mini trucks
- Has a proven enhanced slide bar system for worry free towing
- Full floating head for improved hooking and unhooking, as well as ride
- Jaw handle w/tab for optional padlock security (padlock not included)
- Vertically adjusts from 13” to 17” to best match up with different trailers
- 16K towing capacity, 4K pin weight capacity
- Wide stance one-piece legs for improved stability
- Fits #30035 base rail kit
- 3-year limited warranty



Kit Part#: 30131

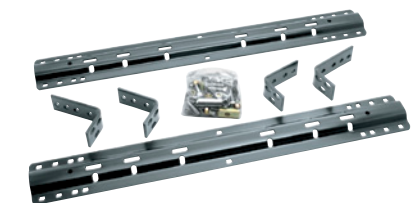

NOTE: Will not fit trucks with beds shorter than 6’ in length unless used with Sidewinder. Will not fit trucks with flareside/stepside.

PART NO.	REF. NO.	DESCRIPTION
30131	297029	16K 5TH WHL HEAD, SUPPORT, SLIDER, 10 BOLT RAIL KIT



TOWING ACCESSORIES



CEQUENT™  
A TRIMAS COMPANY

## Pro Series™ 5th Wheel Hitches



Kit Part#: 30132

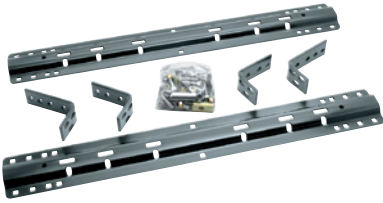

TOWING ACCESSORIES



Kit Part#: 30133

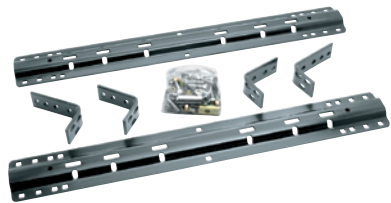

### Pro Series™ 20K

- Covers all 20K user requirements, including light commercial
- Full floating head for improved hooking/unhooking, as well as ride
- Double jaw system completely surrounds the king pin for significantly reduced wear
- Lubricated and clamped side joints for tight and efficient operation
- Lightweight, easy to install and remove
- Adjustable height, from 13” to 17”
- One-piece formed legs, provides wider footprint for superior stability
- Sidewinder compatible, preferred for short bed pick-ups
- Fits 10 bolt rail kit (#30035) Must utilize center attachment points for 20K capacities included w/20K 5th Wheel Hitches.
- Compatible slider system available
- 3-year limited warranty

NOTE: Will not fit trucks with beds shorter than 6’ in length unless used with Sidewinder. Will not fit trucks with flareside/stepsides.

PART NO.	REF. NO.	DESCRIPTION
30132	297023	20K 5TH WHL HEAD, SUPPORT, LEGS,10 BOLT RAIL KIT

### Pro Series™ 20K with Square Tube Slider

Designed for shortbed trucks to provide clearance and prevent damage to truck and trailer in tight spaces at slow speeds.

- 10” travel front to back
- Adjustable with trailer attached
- Can be used with full size or mini trucks
- Double jaw system completely surrounds the king pin for significantly reduced wear
- Full floating head for improved hooking and unhooking, as well as ride
- Jaw handle w/tab for optional padlock security (padlock not included)
- Vertically adjusts from 13” to 17” to best match-up with different trailers
- 20K towing capacity, 5K pin weight capacity
- Wide stance one-piece legs for improved stability
- Fits #30035 base rail kit
- 3-year limited warranty

NOTE: Will not fit trucks with beds shorter than 6’ in length unless used with Sidewinder. Will not fit trucks with flareside/stepsides.

PART NO.	REF. NO.	DESCRIPTION
30133	297025	20K 5TH WHL HEAD, SUPPORT, SLIDER,10 BOLT RAIL KIT

## Pro Series™ 5th Wheel - Gooseneck Hitches & Accessories

### Pro Series™ 25K Above-Bed Gooseneck Plate

- Easy installation and removal allows for full access to truck bed
- Utilizes same base rails (part# 30035 as the 5th Wheel Hitches
- Raised safety chain locations all for easy trailer connection
- 2 5/16" heat treated ball
- In-truck platform rated for 25,000 lbs. gross vehicle towing weight and 6,250 lbs. vertical load
- Ball is offset 2" to accommodate 6 & 8 ft. truck beds
- 5-year limited warranty



PART NO.	REF. NO.	DESCRIPTION
49080	297021	25K GOOSENECK PLATE



TOWING ACCESSORIES

### Pro Series™ 5th Wheel Rails & Installation Kit

For use on all 5th Wheel Hitches except Elite Series® (formerly Signature Series)

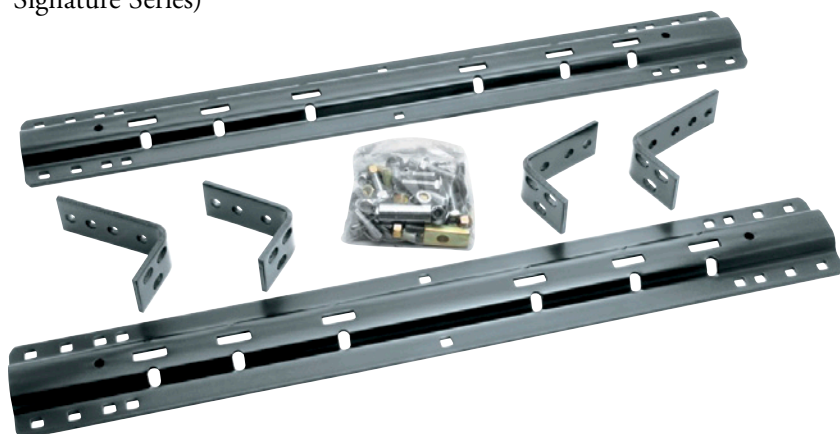

PART NO.	REF. NO.	DESCRIPTION
30035	297086	UNIVERSAL RAIL & BKT KIT FOR PRO SERIES 5TH WHL, 10 BOLT



**CEQUENT™**  
A TRIMAS COMPANY

## Pro Series™ 5th Wheel - Gooseneck Hitches & Accessories

### Installation brackets and hardware for full-size trucks.



**CEQUENT™**  
A TRIMAS COMPANY



Bracket kit for 09 Dodge 1500, including Mega Cab



Bracket kit for 03-09 Dodge Ram 2500/3500 w/overload springs

PART NO.	REF. NO.	DESCRIPTION
58386	297081	UPGRADE BKT KIT FOR 09 DODGE CREW CAB
58186	297082	UPGRAKE BKT KIT FOR 03-09 DODGE 2500/3500 TRUCK

### 5TH WHEEL HITCHES APPLICATION GUIDE

TOWING ACCESSORIES

MAKE	YEAR	MODEL	RAIL KIT	REQUIRED UPGRADE KIT
<b>CHEVY/GMC</b>	73-10	1500, 2500, 3500	30035	N/A
<b>DODGE</b>	94-04	DAKOTA	30035	
	73-89	D/W 100 PICKUP	30035	
	77-93	D/W 150 PICKUP	30035	
	73-80	D/W 200 & 300 PICKUP	30035	
	81-93	D/W 250 & 350 PICKUP	30035	
	94-01	1500	30035	
	09	1500 W/ CREW CAB	30035	58386 BRACKET KIT
	94-02	2500 & 3500	30035	
	03-09	2500 (HAS OVERLOAD SPRINGS)	30035	58186 BRACKET KIT
	03-09	3500	30035	58186 BRACKET KIT
<b>FORD</b>	73-91	F-100, F-150, F-250, F-350	30035	
	92-96	F-150, F-250, F-350	30035	
	97	F-250 & F-350 HEAVY DUTY	30035	
	97-03	F-150 & F-250 LIGHT DUTY	30035	
	04	F-150 HERITAGE SERIES	30035	
	99-11	F-250 & F-350 SUPER DUTY	30035	
<b>NISSAN</b>	04-09	TITAN CREW CAB & KING CAB	30035	58405 BRACKET KIT
<b>TOYOTA</b>	00-06	TUNDRA REG CAB (LONG BED ONLY)	30035	58197 SPACER KIT
	07-10	TUNDRA (EXCEPT CREW MAX)	30035	58309 SPACER KIT

## Hijacker RV 5th Wheels & Gooseneck Hitches

Hijacker offers the most complete line of Fifth Wheel Hitches in the Industry. The two different series of hitches have rails that install either “along the bed” (sliders) or “across the bed” (ultras) and both series have Gooseneck hitches, as well. Enjoy smooth towing with the strongest and most durable Fifth Wheel Hitches on the market. The following features are common to both the Slider Series and the Ultra Series:

- Black powder coat finish
- Jaw bolt adjustment
- Multi position jaw handle
- All 5th wheels have 4” of height adjustment
- Sliding 5th wheels have 8” of adjustment
- Modular concept permits upgrade from 16K single to 16K double pivot to 21K double pivot
- 5 Year warranty
- UPS shippable

### Slider Series

- Rails install *along* the truck bed
- Rails permit easier use of truck bed

PART NO.	REF. NO.	DESCRIPTION	CAPACITY	TONGUE WT.
HJ7001SR	296800	16K SINGLE PIVOT 5TH WHL	16K	4K
HJ7001DPSR	296830	16K DBL PIVOT 5TH WHL	16K	4K
HJ7021DPSR	296850	21K DBL PIVOT 5TH WHL	21K	5.2K
HJ7025GNRSR	296860	25K GN HITCH, 2 5/16” BALL	25K	4.5K



HJ7001SR



HJ7001DPSR

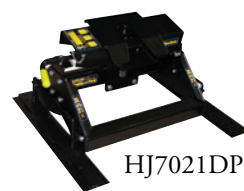

HJ7021DPSR



HJ7025GNRSR

TOWING ACCESSORIES

### Ultra Series

- Rails install *across* the truck bed
- Ultra Slide permits sliding without lowering jacks

PART NO.	REF. NO.	DESCRIPTION	CAP.	TONGUE WT.
HJ7001	296700	16K ULTRA SINGLE PIVOT 5TH WHL	16K	4K
HJ7001DP	296730	16K ULTRA DBL PIVOT 5TH WHL	16K	4K
HJ7021DP	296750	21K ULTRA DBL PIVOT 5TH WHL	21K	5.2K
HJ7025GN	296760	25K GN HITCH, 2 5/16” BALL	25K	4.5K
HJ7001USR	296870	16K SINGLE PIVOT ULTRA SLIDE 5TH WHL	16K	4K
HJ7001DPUSR	296875	16K DBL PIVOT ULTRA SLIDE 5TH WHL	16K	4K
HJ7021DPUSR	296877	21K DBL PIVOT ULTRA SLIDE 5TH WHL	21K	5.2K
HJ24AS18	296895	18K DBL PIVOT ULTRA AUTO SLIDE 5TH WHL HCH	18K	



HJ7001



HJ7021DP



HJ7001DPUSR



HJ7025GN

## Hijacker Installation Brackets & Mounting Rails

Different frame brackets are offered for specific types of vehicles, dramatically reducing installation time of the Hijacker systems. The application chart at the bottom of this page shows how many of each type of bracket are used for each vehicle. The chart below lists the Part No. & Ref. No. for each type of bracket.

PART NO.	REF. NO.	DESCRIPTION	TYPE
SRU411	296900	MTG BKT STD RL FITS MOST TRUCKS	A
SRU411AR	296905	MTG BKT STD RL PRE-88 CHEV, POST92 FORDS	B
SRU411AL	296906	MTG BKT STD RL PRE-88 CHEV, POST92 FORDS	C
SRU411B	296910	MTG BKT STD RL POST 88 CHEV	D
SRU411C	296915	MTG BKT SLDR RL POST 88 CHEV	E
SRU411D	296920	MTG BKT FOR SL MULTI-FORD/DODGE/CHEV	F
SRU411ER	296925	MTG BKT STD RL 99 FORD F250 & F350 SD	G
SRU411EL	296926	MTG BKT STD RL 99 FORD F250 & F350 SD	H
D1535BK	296931	ULTRA BKT DODGE 02-08 1500 03-11 2500 (4x4 & 4x2) & 3500 (4X4 ONLY)	I
D3500BK2	296933	ULTRA MTG BKT DODGE 03-11 3500 (4X2) ONLY	
F150BK04	296935	ULTRA MTG BKT 04-11 FORD F150 UL MODEL ONLY	
F150SLBK	296940	SLIDER MTG BKT 04-11 FORD F150	
FB001001	296950	ULTRA MTG BKT 2011 FORD F250/F350/F450	
FB101001	296951	SLIDER MTG BKT 2011 FORD F250/F350/F450	
FB102001	296952	SLIDER MTG BKT 2011 CHEVY 3/4 & 1 TON 6 1/2' & 8' BOX	
FB002001	296953	ULTRA MTG BKT 2011 CHEVY 3/4 & 1 TON 6 1/2' BOX ONLY	
F350ULBK	297000	ULTRA MTG BKT 08-10 F250-F350SD, 08 F450	
F350SLBK	297010	SLIDER MTG BKT 08-10 F250-350SD, 08-09 F450	
T07ULBK	297020	ULTRA MTG BKT 07-10 TOYOTA TUNDRA	

NOTE: All Hijacker 5th wheel and Gooseneck Hitches come standard with one set (4 ea.) of type A (part # SRU411) bracket

TOWING ACCESSORIES

VEHICLE: FORD	ULTRA SERIES	SLIDER SERIES
04-10 F150 REG/ SUPER CAB ONLY .....	F150BK04.....	F150SLBK
2001 F450/550 "SUPER DUTY" .....	2-A, 1-B, 1-C .....	*
1999-04 F-250/350 "SUPER DUTY" .....	2-A, 1-G, 1-H.....	6-A
05-10 F250/350 "SUPER DUTY" .....	F350ULBK .....	5-A, 1-C
1992-98 F350 .....	2-A, 1-B, 1-C .....	6-A
1997-98 F250 "HEAVY DUTY" .....	2-A, 1-B, 1-C .....	6-A
1997-99 F250 "LIGHT DUTY" .....	4-A .....	6-F
1997-2003 F150 .....	4-A .....	6-F
1989-96 F150/250.....	2-A, 1-B, 1-C .....	6-A
1973-88 F-SERIES.....	2-A, 1-B, 1-C .....	6-A
2000 & EARLIER RANGER.....	** .....	6-D
2011 F250/F350/F450.....	FB001001.....	FB101001

VEHICLE: TOYOTA	ULTRA SERIES	SLIDER SERIES
01-06, 07 & 09 TUNDRA.....	4-A.....	*
2001 & EARLIER TACOMA.....	** .....	6-E
2000 & EARLIER T100 .....	4-A.....	6-E

VEHICLE: DODGE	ULTRA SERIES	SLIDER SERIES
03-09 RAM 3500 2WD ONLY ..	D3500BKT.....	6-F
02-08 RAM 1500 (INCLUDES QUAD CAB) .....	D1535BK.....	6-F
03-09 RAM 2500/3500.....	1-I.....	6-F
94-02 RAM 1500 TO 3500 .....	4-A .....	6-A
93 & EARLIER RAM.....	4-A .....	6-A
03-04 DAKOTA .....	2-A, 1-B, 1-C.....	6-A
01 & EARLIER DAKOTA.....	4-A .....	6-A

VEHICLE: CHEVROLET	ULTRA SERIES	SLIDER SERIES
99-09 SILVERADO & SIERRA, 1500/2500 LONG & SHORTBED ...	4-A.....	6-F
01-09 SILVERADO, 1500 HD LONG & SHORTBED .....	4-A.....	6-F
01-09 SILVERADO, 2500 & 3500 HD LONG & SHORTBED .....	4-A.....	6-F
88-01 3500 LONGBED.....	4-A.....	4-A, 2-E
88-98 1500/2500 LONG & SHORTBED.....	4-A.....	4-A, 2-E
88 & EARLIER S-10.....	** .....	6-A
87 & EARLIER PICKUPS .....	2-A, 2-B.....	*
2011 3/4 & 1TN 6 1/2' BED.....	FB002001 ....	FB102001
2011 3/4 & 1 TON 8' BED .....	N/A .....	FB102001

\* This model not recommended  
\*\* This model will not fit